

### 3-Level IGBT Module

#### 电气特性:

- 650V 沟槽栅/场终止工艺
- 低开关损耗
- 正温度系数

#### 典型应用:

- 三电平应用
- UPS
- 光伏应用

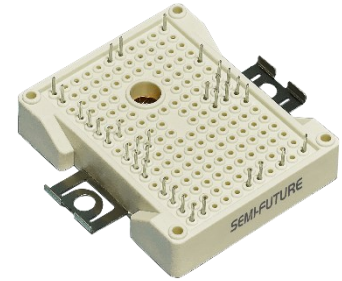
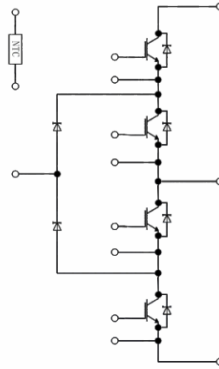

$V_{CES} = 650V$ ,  $I_{C\text{nom}} = 150A$  /  $I_{CRM} = 300A$

### IGBT,逆变器/IGBT, Inverter

#### 最大额定值/Maximum Ratings

Parameter	Conditions	Symbol	Value	Unit
集电极-发射极电压 Collector-Emitter voltage	$T_{vj}=25^{\circ}C$	$V_{CES}$	650	V
连续集电极直流电流 Continuous DC collector current	$T_C=100^{\circ}C$ , $T_{vj\text{max}}=175^{\circ}C$	$I_{C\text{nom}}$	150	A
集电极重复峰值电流 Repetitive peak collector current	$t_p=1\text{ ms}$	$I_{CRM}$	300	A
栅极-发射极电压 Gate emitter voltage		$V_{GE}$	$\pm 20$	V

#### 特征值/Characteristic Values

Parameter	Conditions	Symbol	Value			Unit
			Min.	Typ.	Max.	
集电极-发射极饱和电压 Collector-Emitter saturation voltage	$V_{GE}=15V$ , $I_C=150A$ $V_{GE}=15V$ , $I_C=150A$ $V_{GE}=15V$ , $I_C=150A$	$T_{vj}=25^{\circ}C$ $T_{vj}=125^{\circ}C$ $T_{vj}=150^{\circ}C$	$V_{CESat}$	1.57 1.82 1.86	1.95	V
栅极-发射极阈值电压 Gate-Emitter threshold voltage	$I_C=2.4mA$ , $V_{GE}=V_{CE}$	$T_{vj}=25^{\circ}C$	$V_{GE(th)}$	4.7	5.3	5.9
栅极电荷 Gate charge	$V_{GE} = -15\text{ V} \dots +15\text{ V}$		$Q_G$	1.54		$\mu C$
内部栅极电阻 Internal gate resistor	$T_{vj} = 25^{\circ}C$		$R_{Gint}$	None		$\Omega$
输入电容 Input capacitance	$f=1\text{ MHz}$ , $V_{CE}=25\text{ V}$ , $V_{GE}=0\text{ V}$	$T_{vj}=25^{\circ}C$	$C_{ies}$	16.47		nF

反向传输电容 Reverse transfer capacitance			$C_{res}$		0.27		nF
集电极-发射极截至电流 Collector-emitter cut-off current	$V_{CE}=650V, V_{GE}=0V$	$T_{vj}=25^{\circ}C$	$I_{CES}$			1	mA
栅极-发射极漏电流 Gate-emitter leakage current	$V_{CE}=0V, V_{GE}=20V$	$T_{vj}=25^{\circ}C$	$I_{GES}$			400	nA
开通延迟时间 Turn-on delay time	$I_C=150A, V_{CE}=300V$ $V_{GE}=\pm 15V, R_G=3.3\Omega$ (inductive load)	$T_{vj}=25^{\circ}C$ $T_{vj}=125^{\circ}C$ $T_{vj}=150^{\circ}C$	$t_{d\ on}$		12 12 14		ns
上升时间 Rise time	$I_C=150A, V_{CE}=300V$ $V_{GE}=\pm 15V, R_G=3.3\Omega$ (inductive load)	$T_{vj}=25^{\circ}C$ $T_{vj}=125^{\circ}C$ $T_{vj}=150^{\circ}C$	$t_r$		28 29 31		
关断延迟时间 Turn-off delay time	$I_C=150A, V_{CE}=300V$ $V_{GE}=\pm 15V, R_G=3.3\Omega$ (inductive load)	$T_{vj}=25^{\circ}C$ $T_{vj}=125^{\circ}C$ $T_{vj}=150^{\circ}C$	$t_{d\ off}$		167 180 182		
下降时间 Fall time	$I_C=150A, V_{CE}=300V$ $V_{GE}=\pm 15V, R_G=3.3\Omega$ (inductive load)	$T_{vj}=25^{\circ}C$ $T_{vj}=125^{\circ}C$ $T_{vj}=150^{\circ}C$	$t_f$		54 59 63		
开通损耗能量 Turn-on energy loss per pulse	$I_C=150A, V_{CE}=300V$ $V_{GE}=\pm 15V, R_G=3.3\Omega$ (inductive load)	$T_{vj}=25^{\circ}C$ $T_{vj}=125^{\circ}C$ $T_{vj}=150^{\circ}C$	$E_{on}$		0.66 0.83 0.91		mJ
关断损耗能量 Turn-off energy loss per pulse	$I_C=150A, V_{CE}=300V$ $V_{GE}=\pm 15V, R_G=3.3\Omega$ (inductive load)	$T_{vj}=25^{\circ}C$ $T_{vj}=125^{\circ}C$ $T_{vj}=150^{\circ}C$	$E_{off}$		1.28 1.66 1.80		
在开关状态下温度 Temperature under switching conditions			$T_{vj\ op}$	-40		150	$^{\circ}C$

## 二极管, 逆变器/Diode, Inverter

### 最大额定值/Maximum Ratings

Parameter	Conditions	Symbol	Value	Unit
反向重复峰值电压 Repetitive peak reverse voltage	$T_{vj}=25^{\circ}C$	$V_{RRM}$	650	V
连续正向直流电流 Continuous DC forward current		$I_F$	150	A
正向重复峰值电流 Repetitive peak forward current	$t_p=1ms$	$I_{FRM}$	300	A
I <sup>2</sup> t-值 I <sup>2</sup> t-value	$V_R=0V, t_p=10ms, T_{vj}=125^{\circ}C$	$I^2t$	1200	A <sup>2</sup> s

### 特征值/Characteristic Values

Parameter	Conditions	Symbol	Value			Unit
			Min.	Typ.	Max.	

正向电压 Forward voltage	$I_F=150A, V_{GE}=0V$ $I_F=150A, V_{GE}=0V$ $I_F=150A, V_{GE}=0V$	$T_{vj}=25^{\circ}C$ $T_{vj}=125^{\circ}C$ $T_{vj}=150^{\circ}C$	$V_F$		1.62 1.71 1.69	2.00	V
反向恢复峰值电流 Peak reverse recovery current	$I_F = 150 A,$ $-diF/dt = 4281A/\mu s(T_{vj}=150^{\circ}C)$ $VR = 300 V, V_{GE} = -15 V$	$T_{vj}=25^{\circ}C$ $T_{vj}=125^{\circ}C$ $T_{vj}=150^{\circ}C$	$I_{RM}$		83 102 112		A
恢复电荷 Recovered charge	$I_F = 150 A,$ $-diF/dt = 4281A/\mu s(T_{vj}=150^{\circ}C)$ $VR = 300 V, V_{GE} = -15 V$	$T_{vj}=25^{\circ}C$ $T_{vj}=125^{\circ}C$ $T_{vj}=150^{\circ}C$	$Q_r$		3.05 5.32 6.17		$\mu C$
反向恢复损耗（每脉冲） Reverse recovered energy	$I_F = 150 A,$ $-diF/dt = 4281A/\mu s(T_{vj}=150^{\circ}C)$ $VR = 300 V, V_{GE} = -15 V$	$T_{vj}=25^{\circ}C$ $T_{vj}=125^{\circ}C$ $T_{vj}=150^{\circ}C$	$E_{rec}$		0.69 1.28 1.49		mJ
在开关状态下温度 Temperature under switching conditions			$T_{vj op}$	-40		150	$^{\circ}C$

## 二极管, D5-D6/Diode, D5-D6

### 最大额定值/Maximum Ratings

Parameter	Conditions	Symbol	Value	Unit
反向重复峰值电压 Repetitive peak reverse voltage	$T_{vj}=25^{\circ}C$	$V_{RRM}$	650	V
连续正向直流电流 Continuous DC forward current		$I_F$	150	A
正向重复峰值电流 Repetitive peak forward current	$t_p=1ms$	$I_{FRM}$	300	A
$I^2t$ 值 $I^2t$ -value	$t_p=10ms, \sin 180^{\circ}, T_{vj}=125^{\circ}C$	$I^2t$	1200	$A^2s$

### 特征值/Characteristic Value

Parameter	Conditions	Symbol	Value			Unit
			Min.	Typ.	Max.	
正向电压 Forward voltage	$I_F=150A, V_{GE}=0V$ $I_F=150A, V_{GE}=0V$ $I_F=150A, V_{GE}=0V$	$V_F$		1.65 1.76 1.73	2.00	V
反向电流 Reverse current	$I_F = 150 A,$ $- diF/dt=4281A/\mu s(T_{vj}=150^{\circ}C)$ $VR = 300 V$	$I_{RM}$		83 102 112		A
恢复电荷 Recovered charge	$I_F = 150 A,$ $- diF/dt=4281A/\mu s(T_{vj}=150^{\circ}C)$ $VR = 300 V$	$Q_r$		3.05 5.32 6.17		$\mu C$
反向恢复损耗（每脉冲） Reverse recovery energy	$I_F = 150 A,$ $- diF/dt=4281A/\mu s(T_{vj}=150^{\circ}C)$ $VR = 300 V$	$E_{rec}$		0.69 1.28 1.49		mJ
在开关状态下温度 Temperature under switching conditions		$T_{vj op}$	-40		150	$^{\circ}C$

负温度系数热敏电阻/NTC-Thermistor

## 特征值/Characteristic Values

Parameter	Conditions	Symbol	Value			Unit
			Min.	Typ.	Max.	
额定电阻值 Rated resistances	$T_C=25^{\circ}\text{C}$ , $\pm 5\%$	$R_{25}$		5		$\text{k}\Omega$
B-值 B-value	$\pm 1\%$	$B_{25/50}$		3380		K

模块 / Module

Parameter	Conditions	Symbol	Value			Unit
绝缘测试电压 Isolation test voltage	RMS, $f=50\text{Hz}$ , $t=60\text{s}$	$V_{\text{ISOL}}$	2500			V
内部绝缘 Internal isolation			$\text{Al}_2\text{O}_3$			
储存温度 Storage temperature		$T_{\text{stg}}$	-40		125	$^{\circ}\text{C}$
模块安装的扭矩 Mounting torque for modul mounting		M	3.0		6.0	Nm
重量 Weight		W		41		g



图 1. 典型输出特性 ( $V_{GE}=15V$ )

Figure 1. Typical output characteristics ( $V_{GE}=15V$ )

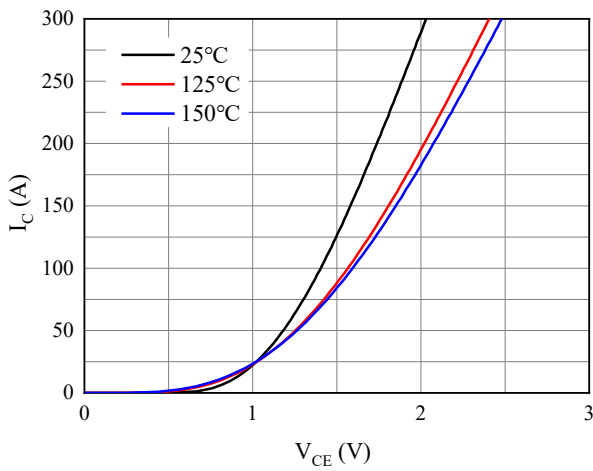

图 2. 典型输出特性 ( $T_{vj}=150^{\circ}C$ )

Figure 2. Typical output characteristics ( $T_{vj}=150^{\circ}C$ )

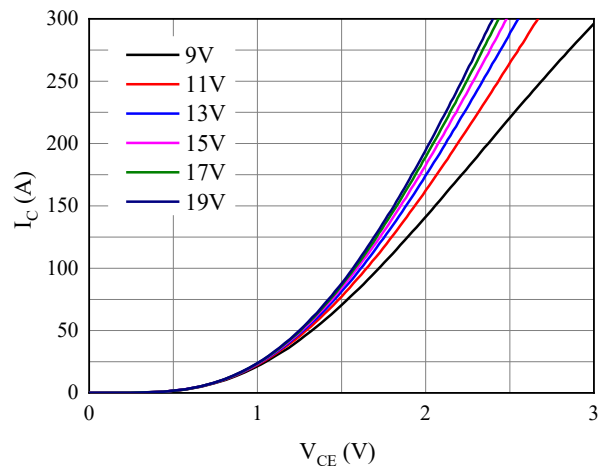

图 3. 典型传输特性 ( $V_{CE}=20V$ )

Figure 3. Typical transfer characteristic ( $V_{CE}=20V$ )

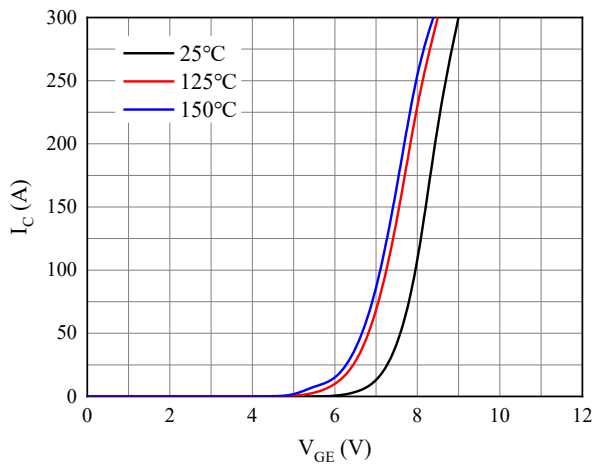

图 4. 正向偏压特性 二极管

Figure 4. Forward characteristic of Diode

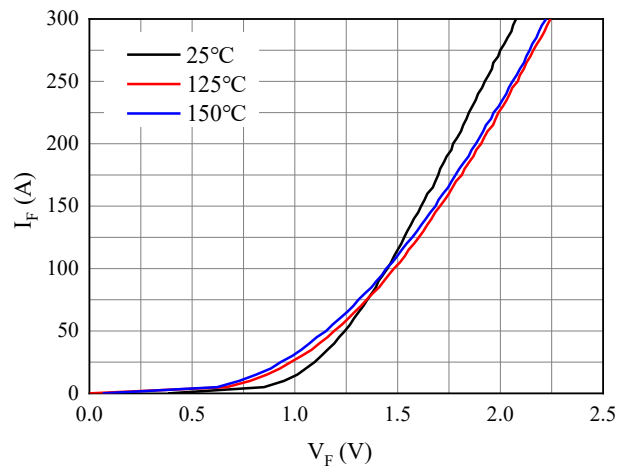

图 5. 电容特性

Figure 5. Capacitance characteristic

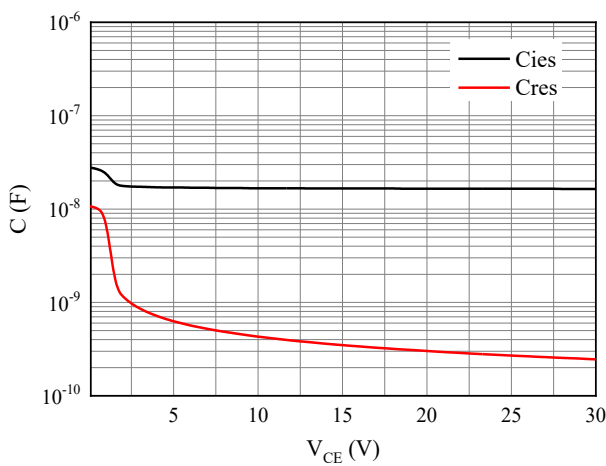

图 6. 正向偏压特性 二极管 D5-D6

Figure 6. Forward characteristic of Diode, D5-D6

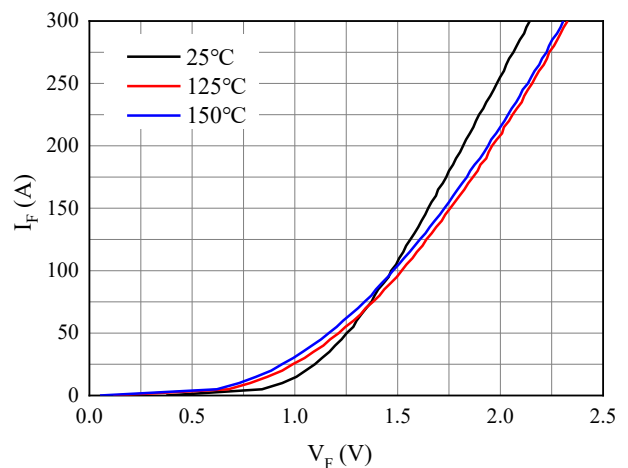

图 7. 开关损耗 逆变器

Figure 7. Switching losses of IGBT  
VGE=±15V, RGon=3.3Ω, RGoff=3.3Ω, VCE=300V

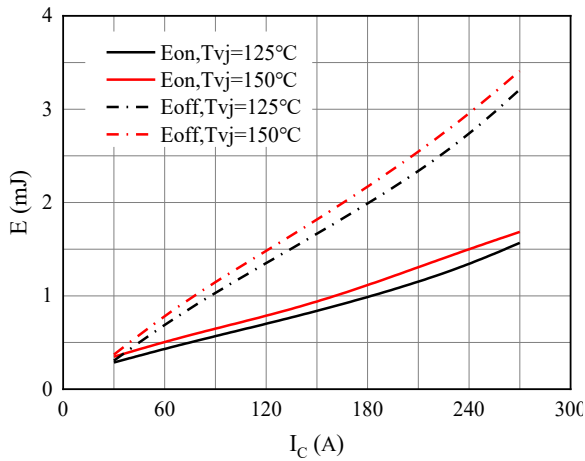

图 8. 开关损耗 逆变器

Figure 8. Switching losses of IGBT  
VGE=±15V, IC=150A, VCE=300V

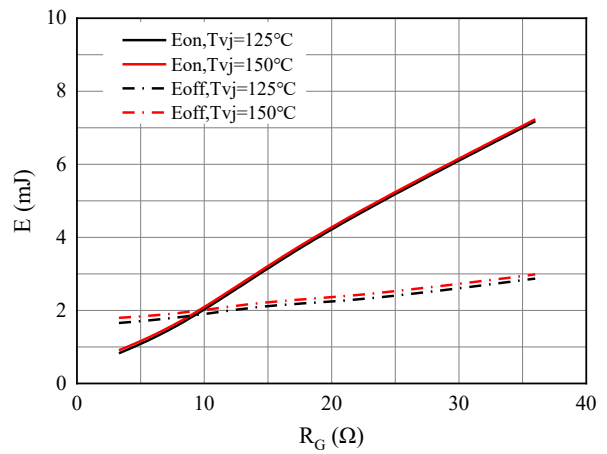

图 9. 开关损耗 二极管

Figure 9. Switching losses of Diode  
RGon=3.3Ω, VCE=300V

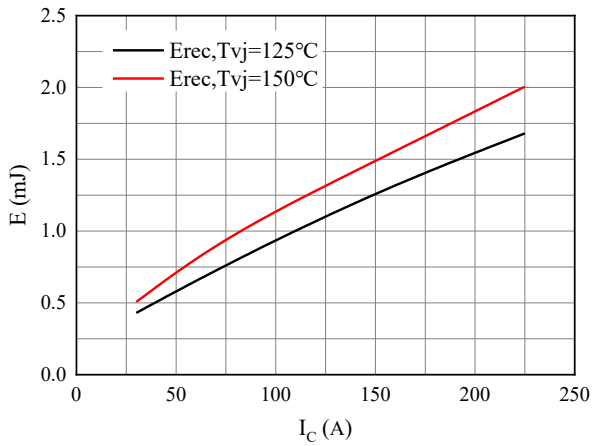

图 10. 开关损耗 二极管

Figure 10. Switching losses of Diode  
IF=150A, VCE=300V

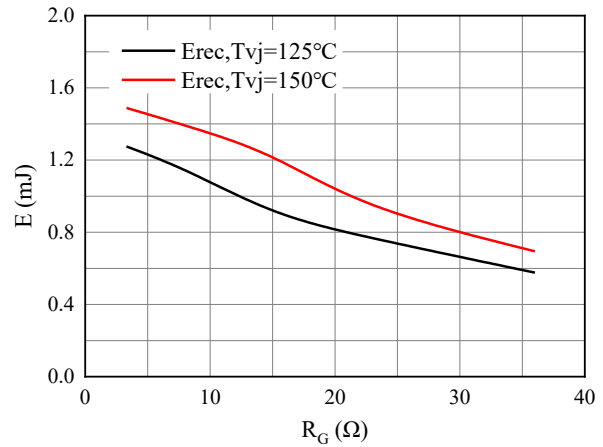

图 11. 负温系数热敏电阻 温度特性

Figure 11. NTC-Themistor-temperature characteristic

Circuit diagram

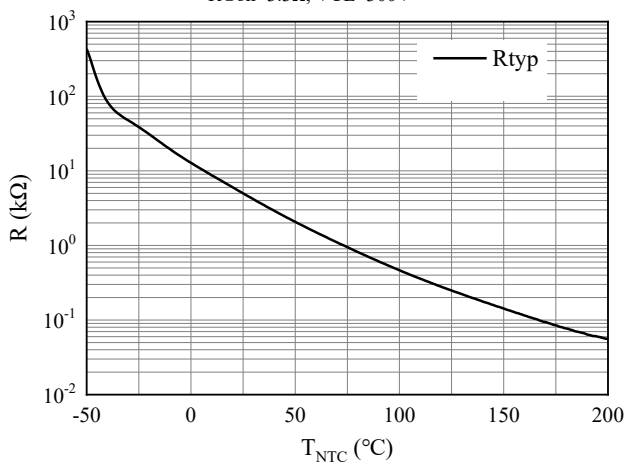
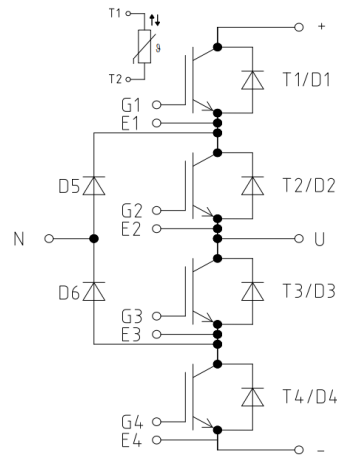

Package outlines

